

# Temporäre und Mobile Bodenschutzsysteme

## Produktinformationen und technische Daten

Einsatzgebiete unserer Produkte zum mobilen Bodenschutz:



Schwerlasttransporte



Temporäre Gehwege



Konzerte und Events



Ästhetische Eventböden



Mobile Kranstellflächen



Leitungsbau



Mobile Parkplätze



Mobile Logistik



Windkraft-Anlagenbau



Zeltböden



Straßenbau und Zufahrtswege



Sonderprojekte

## SYSTEMA Flex

**Material:**

Kunststoff - Recyclat

**Maße in mm:**

320 (Kantenlänge ) x 40

**Gewicht pro Panel:**

ca. 3,2 kg

**Oberfläche & Farbe:**

grün

**Traglast:**

ca. 7,5t (Abhängig vom  
Untergrund)

**Transport pro LKW:**

16 Paletten (1.030m<sup>2</sup>)

0,27m<sup>2</sup>  
pro Panel



**Anwendungsbereiche:**



Konzerte  
und Events



Temporäre  
Gehwege



Mobile  
Parkplätze



Ästhetische  
Eventböden



Zeltböden



# SYSTEMA Classic

**Material:**

Bruchfestes Polyethylen

**Maße in mm:**

492 x 492 x 34

**Gewicht pro Panel:**

ca. 1,48 kg

**Oberfläche & Farbe:**

Grau

**Traglast:**

ca. 2t (Abhängig vom Untergrund)

**Transport pro LKW:**

24 Paletten (1.200m<sup>2</sup>)

0,24m<sup>2</sup>  
Nutzfläche  
pro Panel

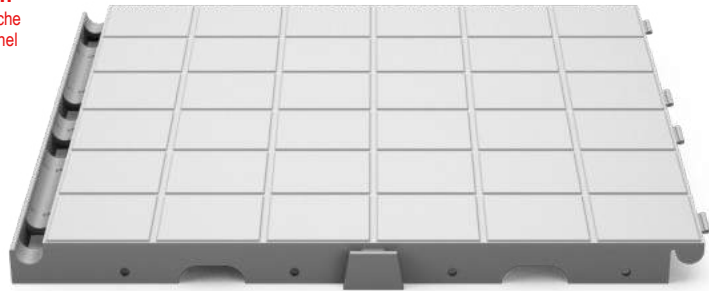

**Anwendungsbereiche:**



Konzerte  
und Events



Temporäre  
Gehwege



Mobile  
Parkplätze



Ästhetische  
Eventböden



Zeltböden

**Rampen:**



# SYSTEMA Drain

**Material:**

Bruchfestes Polyethylen

**Maße in mm:**

492 x 492 x 34

**Gewicht pro Panel:**

ca. 1,48 kg

**Oberfläche & Farbe:**

Grau

**Traglast:**

ca. 2t (Abhängig vom Untergrund)

**Transport pro LKW:**

24 Paletten (1.200m<sup>2</sup>)

0,24m<sup>2</sup>  
Nutzfläche  
pro Panel

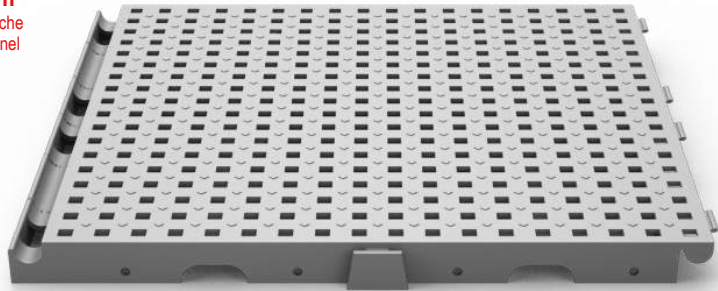

**Anwendungsbereiche:**



Konzerte  
und Events



Temporäre  
Gehwege



Mobile  
Parkplätze



Ästhetische  
Eventböden



Zeltböden

**Rampen:**

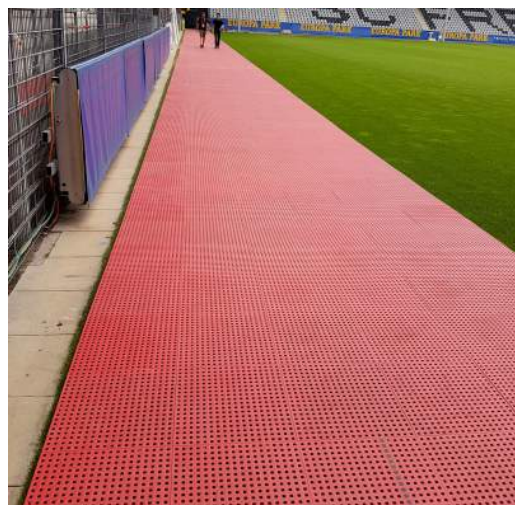

# SYSTEMA

## Cargo

**Material:**

PVC aus Recycling

**Maße in mm:**

1200 x 800 x 43

**Gewicht pro Panel:**

ca. 32 kg

**Oberfläche & Farbe:**

2mm Profil einseitig  
schwarz-bunt

**Traglast:**

ca. 40t (Abhängig vom  
Untergrund)

**Transport pro LKW:**

1. 200 St (1.050m<sup>2</sup>)

0,88m<sup>2</sup>  
Nutzfläche  
pro Panel

Profil 2mm

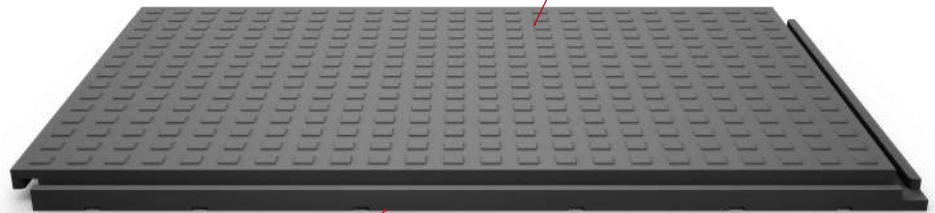

Overlap-  
Panel

**Anwendungsbereiche:**



Straßenbau  
und Zufahrtswege



Konzerte  
und Events



Mobile  
Parkplätze



Temporäre  
Gehwege



Mobile  
Logistik

**Rampen:**



## SYSTEMA Public

**Material:**

PVC aus Recycling

**Maße in mm:**

1200 x 800 x 22

**Gewicht pro Panel:**

ca. 20 kg

**Oberfläche & Farbe:**

2mm Profil einseitig  
schwarz-bunt

**Traglast:**

ca. 20t (Abhängig vom  
Untergrund)

**Transport pro LKW:**

1. 200 St (1.050m<sup>2</sup>)

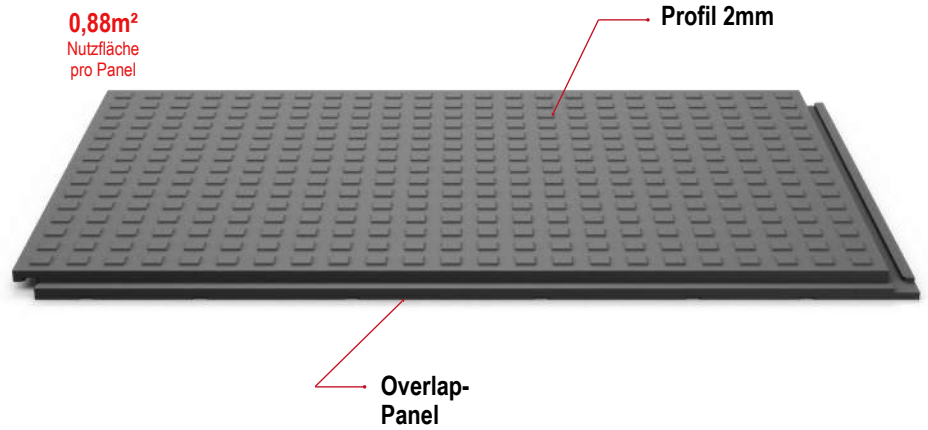

**Anwendungsbereiche:**



*Straßenbau  
und Zufahrtswege*



*Konzerte  
und Events*



*Mobile  
Parkplätze*



*Temporäre  
Gehwege*



*Mobile  
Logistik*

**Rampen:**

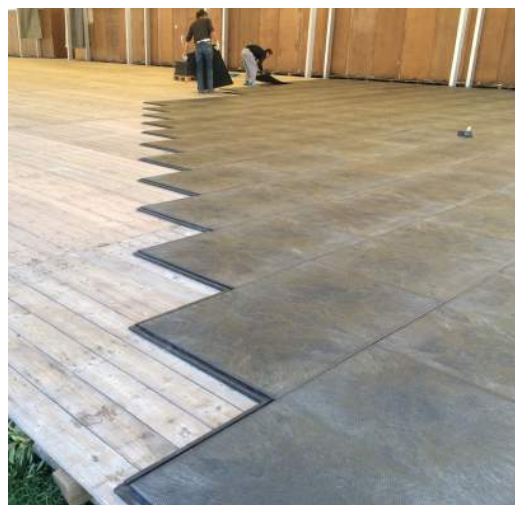

# VARIO matbasic

**Material:**

Polyethylen, hochmolekular

**Maße in mm:**

1000 x 2000 x 12

**Gewicht pro Panel:**

ca. 22 kg

**Oberfläche & Farbe:**

Unterseite angeraut  
Oberseite unprofiliert  
schwarz

**Traglast:**

ca. 50t (abhängig vom  
Untergrund)

**Transport pro LKW:**

1050st (2100m<sup>2</sup>)

**Gestell::**

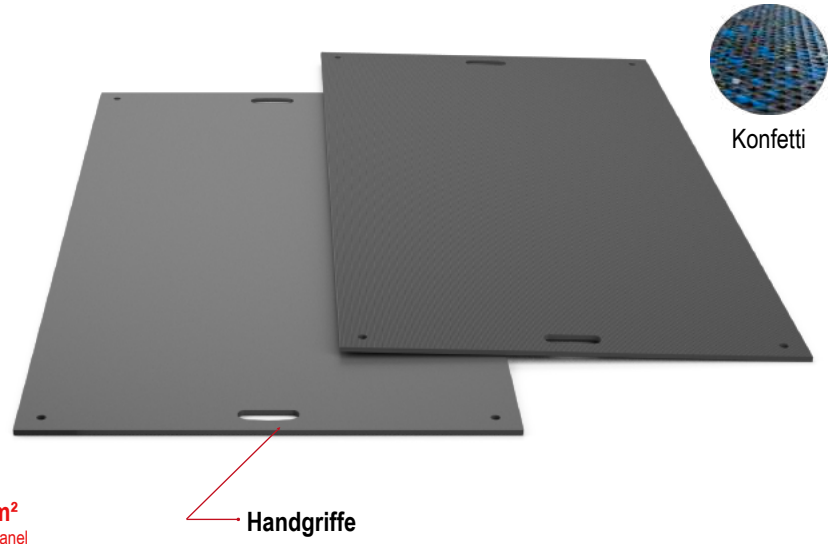

2 m<sup>2</sup>  
pro Panel

Handgriffe

**Anwendungsbereiche:**



*Straßenbau  
und Zufahrtswege*



*Konzerte  
und Events*



*Temporäre  
Gehwege*



*Mobile  
Logistik*



*Leitungsbau*



*Mobile  
Parkplätze*



## VARIO mat 1+

**Material:**

Polyethylen, hochmolekular

**Maße in mm:**

1200 x 2400 x 17 (inkl. Profil)

**Gewicht pro Panel:**

ca. 36 kg

**Oberfläche & Farbe:**

Unterseite Riffelung (AS)

Oberseite 5mm Profil

schwarz-bunt

**Traglast:**

ca. 80t (abhängig vom Untergrund)

**Transport pro LKW:**

600st (1728m<sup>2</sup>)

**Schrauben und Gestell:**

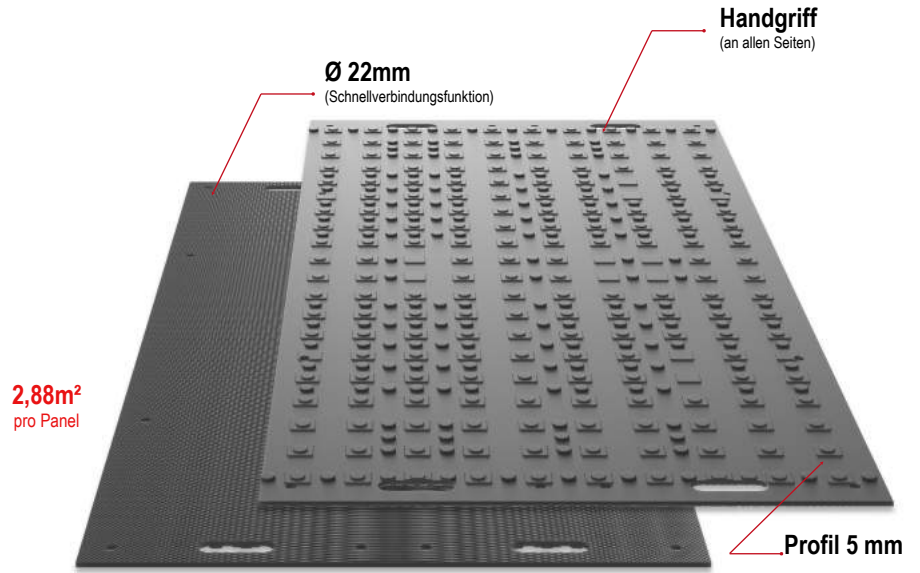

**Anwendungsbereiche:**



Straßenbau  
und Zufahrtswege



Konzerte  
und Events



Temporäre  
Gehwege



Mobile  
Logistik



Leitungsbau



Mobile  
Parkplätze





# VARIO mat2

**Material:**

Polyethylen, hochmolekular

**Maße in mm:**

1000 x 2000 x 31,5 (inkl. Profil)

**Gewicht pro Panel:**

ca. 40,5 kg

**Oberfläche & Farbe:**

5mm & 2,5mm Profil  
schwarz-bunt

**Traglast:**

ca. 130t (abhängig vom  
Untergrund)

**Transport pro LKW:**

540st (923m<sup>2</sup>)

**Schrauben und Gestell:**



**MIETEN KAUFEN SERVICE**

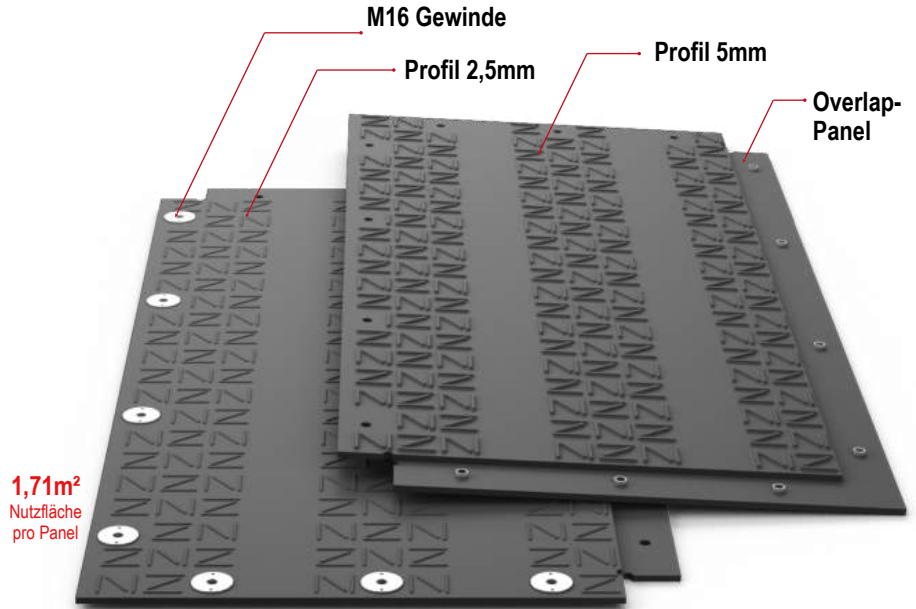

**Anwendungsbereiche:**



Mobile  
Kranstellflächen



Schwerlast-  
transporte



Mobile  
Logistik



Windkraft-  
Anlagenbau



Temporäre  
Gehwege



Straßenbau  
und Zufahrtswege



Leitungsbau



Konzerte  
und Events



Mobile  
Parkplätze

**Rampen:**



**VARIO  
mat3**

**Material:**

Polyethylen, hochmolekular

**Maße in mm:**

2000 x 3000 x 45,5 (inkl. Profil)

**Gewicht pro Panel:**

ca. 221 kg

**Oberfläche & Farbe:**

5mm & 2,5mm Profil  
schwarz-bunt

**Traglast:**

ca. 150t (abhängig vom  
Untergrund)

**Transport pro LKW:**

100st (600m<sup>2</sup>)

**Schrauben und Verbinder:**

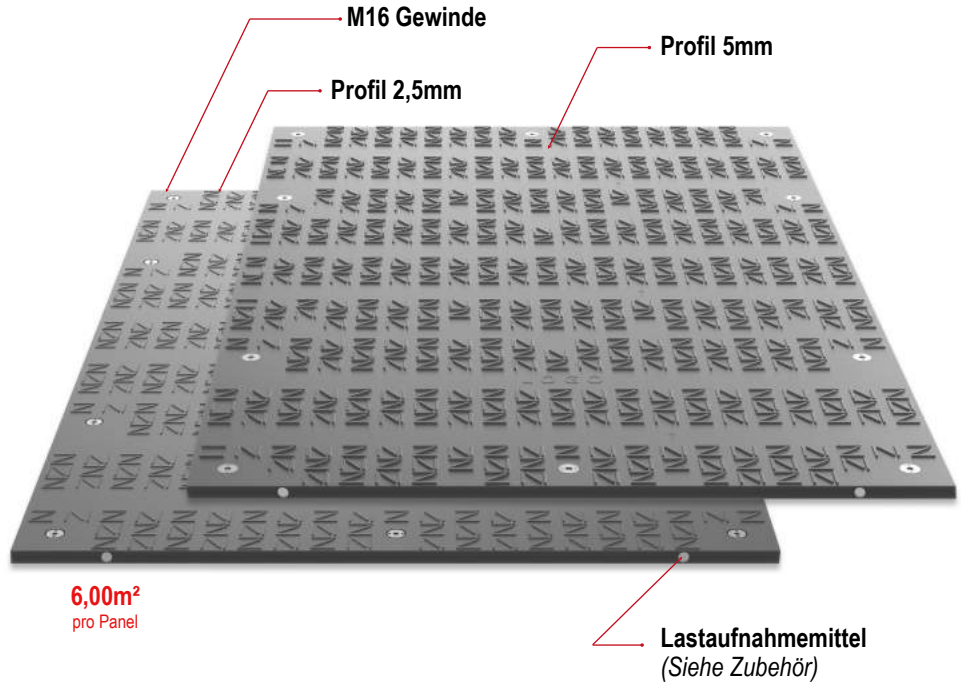

**Anwendungsbereiche:**



Mobile  
Kranstellflächen



Schwerlast-  
transporte



Mobile  
Logistik



Windkraft-  
Anlagenbau



Temporäre  
Gehwege



Straßenbau  
und Zufahrtswege



Leitungsbau



Konzerte  
und Events



Mobile  
Parkplätze

**Rampen:**



# VARIO mat F

**Material:**

Polyethylen, hochmolekular

**Maße in mm:**

2400 x 3000 x 32,5 (inkl. Profil)

**Gewicht pro Panel:**

ca. 210 kg

**Oberfläche & Farbe:**

Unterseite Riffelung (AS)

Oberseite 5mm Profil

schwarz-bunt

**Traglast:**

ca. 130t (abhängig vom Untergrund)

**Transport pro LKW:**

100st (720m<sup>2</sup>)

**Schrauben und Verbinder:**

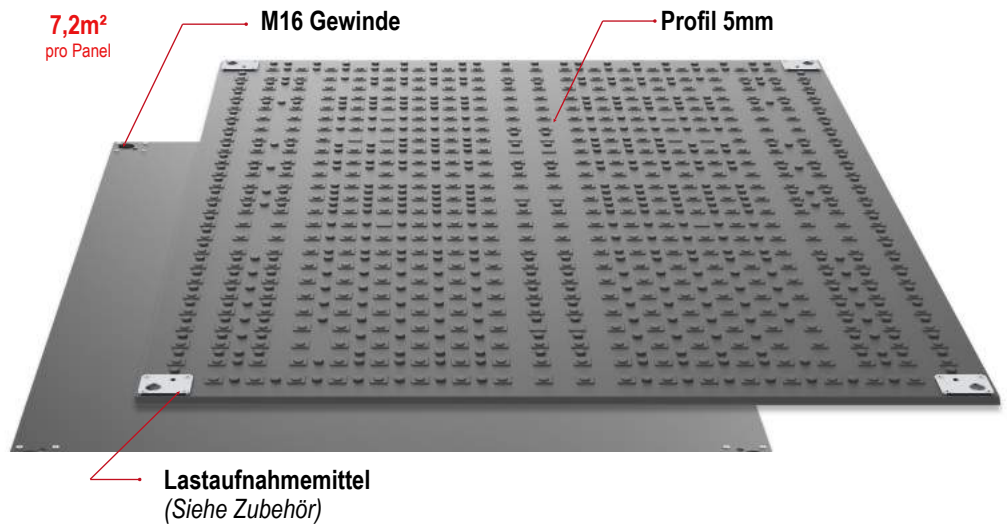
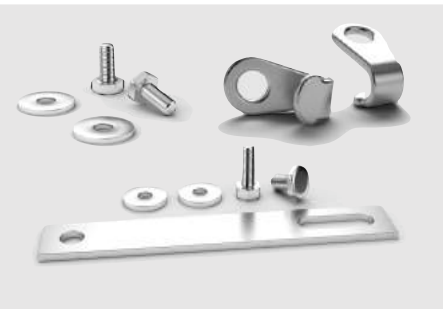

**Anwendungsbereiche:**



Mobile Kranstellflächen



Schwerlasttransporte



Mobile Logistik



Windkraft-Anlagenbau



Temporäre Gehwege



Straßenbau und Zufahrtswege



Leitungsbau



Konzerte und Events



Mobile Parkplätze



# VARIO matTT

**Material:**

Polyethylen, hochmolekular

**Maße in mm:**

3000 x 2500 x 35,5 (inkl. Profil)

**Gewicht pro Panel:**

ca. 288 kg

**Oberfläche & Farbe:**

Unterseite Riffelung (AS)

Oberseite 5mm Profil

schwarz-bunt

**Traglast:**

ca. 160t (abhängig vom

Untergrund)

**Transport pro LKW:**

80st (600m<sup>2</sup>)

**Schrauben und Verbinder:**

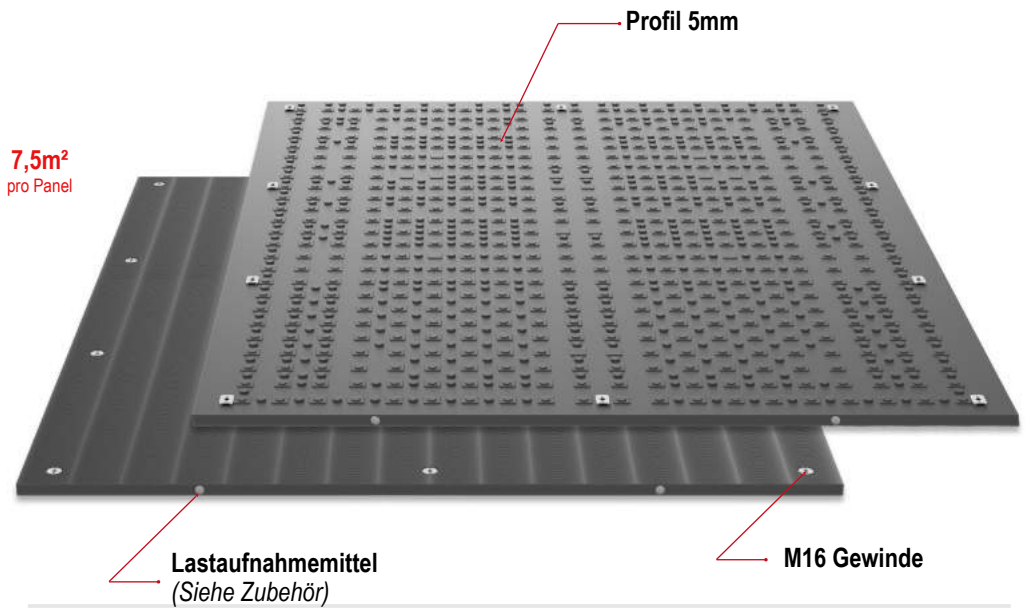
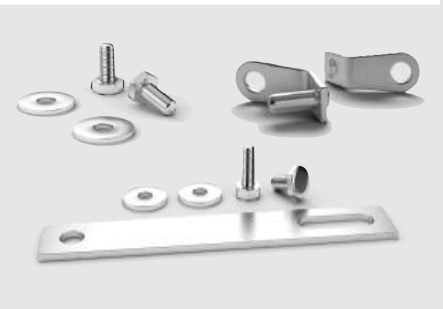

**Anwendungsbereiche:**



Mobile Kranstellflächen



Schwerlasttransporte



Mobile Logistik



Windkraft-Anlagenbau



Temporäre Gehwege



Straßenbau und Zufahrtswege



Leitungsbau



Konzerte und Events



Mobile Parkplätze



# Zäune

**Material:**

fZaungitter : galvanisierter Stahl

**Maße in m:**

3.50 x 0.04 x 2.00 m

**Gewicht je Zaun:**

Approx. 16 kg

**Transport pro LKW:**

29 Zäune pro LKW 8 Transportgestelle  
je standard LKW ca. 812 m (2,664 ft)  
Gesamtlänge

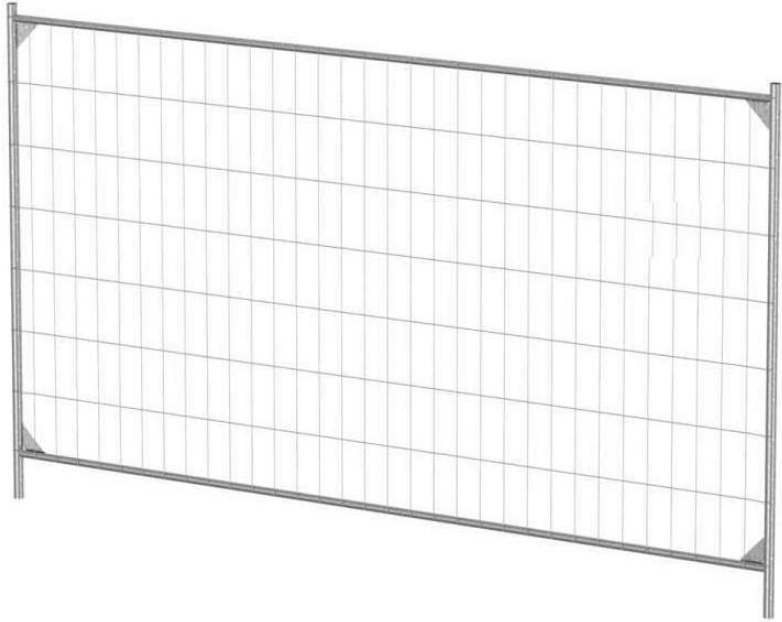

**Anwendungsbereiche:**



Mobile  
Kranstellflächen



Schwerlast-  
transporte



Mobile  
Logistik



Windkraft-  
Anlagenbau



Temporäre  
Gehwege



Straßenbau  
und Zufahrtswege



Leitungsbau



Konzerte  
und Events



Mobile  
Parkplätze

**Zubehör:**



# Absperrgitter

**Material:**

feuerverzinkte Stahlrohre

**Maße in m:**

2.50 x 0.03 x 1.20 m

**Gewicht pro Gitter:**

ca. 18 kg

**Transport pro LKW:**

2.50 m (98 in) Absperrgitter:

ca. 1,500 m (4,921 ft)

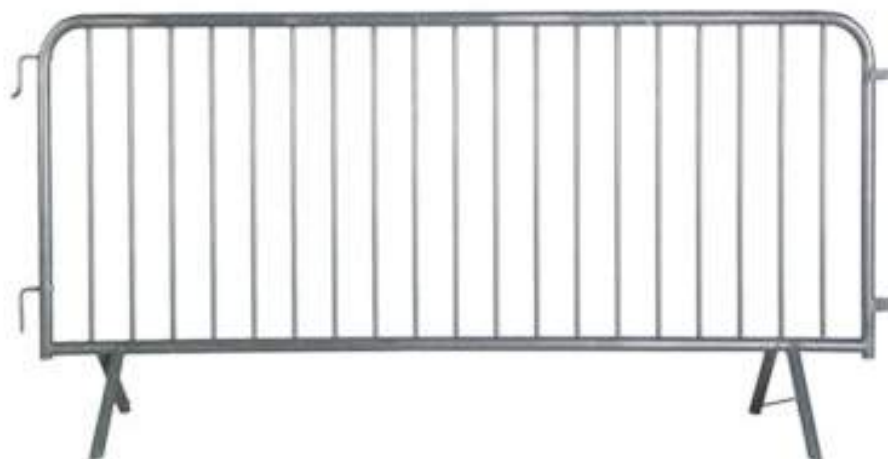

**Anwendungsbereiche:**



Mobile Kranstellflächen



Schwerlasttransporte



Mobile Logistik



Windkraft-Anlagenbau



Temporäre Gehwege



Straßenbau und Zufahrtswege



Leitungsbau



Konzerte und Events



Mobile Parkplätze



## Zelte

Unsere Zelte sind in einer Vielzahl von Standardgrößen und -stilen sowie kundenspezifischen Konfigurationen erhältlich. Die flexiblen und kreativen Konstruktionen eignen sich für zahlreiche Veranstaltungen und Umgebungen. Zelte können schnell errichtet werden, um nutzbare Veranstaltungsflächen zu erweitern, und auf maßgeschneiderte Anforderungen zugeschnitten werden. Zudem bieten wir ein breites Sortiment an Extras, wie Möbel, Küchen und Küchenzubehör bis hin zu Heizungen und Klimaanlage.



### Anwendungsbereiche:



Mobile  
Kranstellflächen



Schwerlast-  
transporte



Mobile  
Logistik



Windkraft-  
Anlagenbau



Temporäre  
Gehwege



Straßenbau  
und Zufahrtswege



Leitungsbau



Konzerte  
und Events



Mobile  
Parkplätze



# Container

Container- und Portacabin-Module können einzeln installiert oder zu ganzen Gebäudekomplexen kombiniert werden. Alle unsere Systeme sind hochgradig anpassungsfähig, schnell und einfach zu installieren. Alle Container sind abschließbar und mit Stromanschlüssen, Elektroheizungen und Klimaanlage ausgestattet. Es sind Tür- und Fensterkonfigurationen verfügbar.



### Anwendungsbereiche:



Mobile Kranstellflächen



Schwerlasttransporte



Mobile Logistik



Windkraft-Anlagenbau



Temporäre Gehwege



Straßenbau und Zufahrtswege



Leitungsbau



Konzerte und Events



Mobile Parkplätze





## Kabelbrücken

Kabelbrücken schützen Kabel. Außerdem schaffen sie gut begeh- und befahrbare Flächen. Diese können Veranstaltungen, Baustellen und mehr absichern. Kabelbrücken schützen auf zwei Arten. Erstens führen sie Kabel und Schläuche unterschiedlicher Bauart in geordneten Bahnen über das Gelände und decken sie sicher ab. Zum anderen eröffnet diese Art der Überbrückung kantenfreie Bereiche für Fußgänger und Fahrzeuge gleichermaßen. Sie können diese Bereiche problemlos begehen und befahren.



### Anwendungsbereiche:



Mobile  
Kranstellflächen



Schwerlast-  
transporte



Mobile  
Logistik



Windkraft-  
Anlagenbau



Temporäre  
Gehwege



Straßenbau  
und Zufahrtswege



Leitungsbau



Konzerte  
und Events



Mobile  
Parkplätze



## Mobile Beleuchtung

Die leistungsstarke, transportable Flutlichtanlage beleuchtet Fluchtwege. Außerdem kann sie bei Einbruch der Dunkelheit Sanitärbereiche beleuchten. Ebenso bietet sie während der Auf- oder Abbauphase ein günstiges Arbeitslicht. Auf diese Weise schafft es eine sichere Umgebung. Gäste und Crewmitglieder finden sich jederzeit zurecht.



### Anwendungsbereiche:



Mobile Kranstellflächen



Schwerlasttransporte



Mobile Logistik



Windkraft-Anlagenbau



Temporäre Gehwege



Straßenbau und Zufahrtswege



Leitungsbau



Konzerte und Events



Mobile Parkplätze



## Octanorm System

Vom Entwurf bis zur Installation bieten Expo-Messestände schlüsselfertige Ausstellungslösungen für alle Ihre Anforderungen. Wir helfen Ihnen, die besten Messestände zu entwerfen, die Ihren Anforderungen gerecht werden.



### Anwendungsbereiche:



Mobile  
Kranstellflächen



Schwerlast-  
transporte



Mobile  
Logistik



Windkraft-  
Anlagenbau



Temporäre  
Gehwege



Straßenbau  
und Zufahrtswege



Leitungsbau



Konzerte  
und Events



Mobile  
Parkplätze



## Tribünen

Unsere mobilen Tribünen werden im Innen- und Außenbereich für alle Arten von Veranstaltungen eingesetzt.

Sie sind einfach und schnell montiert und demontiert.

Durch ihren flexiblen und modularen Aufbau können die Tribünen auf allen Untergründen und für Ihr ganz individuelles Projekt eingesetzt werden.



### Anwendungsbereiche:



Mobile  
Kranstellflächen



Schwerlast-  
transporte



Mobile  
Logistik



Windkraft-  
Anlagenbau



Temporäre  
Gehwege



Straßenbau  
und Zufahrtswege



Leitungsbau



Konzerte  
und Events



Mobile  
Parkplätze



## Büro Container

Unsere Bürocontainer sind für den ganzjährigen Einsatz gebaut. Wir haben sie individuell für unsere Kunden als schnelle, kostengünstige und flexible Lösung konzipiert. Sie sind auch mit Möbeln und Extras erhältlich.

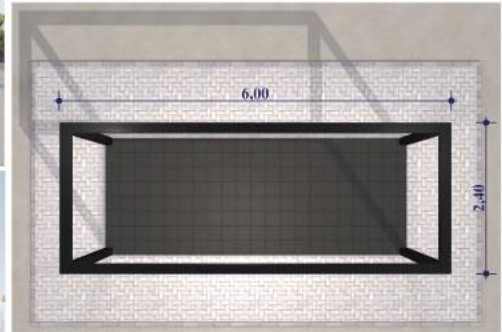

### Anwendungsbereiche:



Mobile Kranstellflächen



Schwerlasttransporte



Mobile Logistik



Windkraft-Anlagenbau



Temporäre Gehwege



Straßenbau und Zufahrtswege



Leitungsbau



Konzerte und Events



Mobile Parkplätze

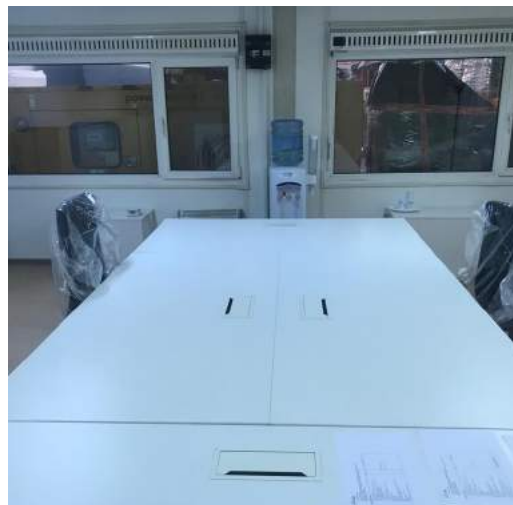

## Mobiles WC

Unser mobiles WC ist für den ganzjährigen Einsatz konzipiert. Es kann auf allen Oberflächen verwendet werden. Sie sind auch mit Wassertank erhältlich.



### Anwendungsbereiche:



Mobile Kranstellflächen



Schwerlasttransporte



Mobile Logistik



Windkraft-Anlagenbau



Temporäre Gehwege



Straßenbau und Zufahrtswege



Leitungsbau



Konzerte und Events



Mobile Parkplätze

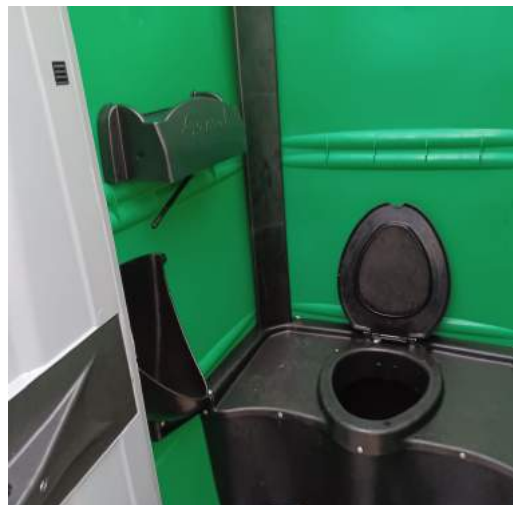

## Messestände

Die Messestände werden individuell für unsere Kunden gestaltet.  
 Sie lassen sich schnell und einfach montieren.  
 Wir bieten die ideale Lösung für die Präsentation Ihrer Produkte und Ihres Unternehmens.  
 Auf Wunsch sind auch Möbel erhältlich.



### Anwendungsbereiche:



Mobile  
Kranstellflächen



Schwerlast-  
transporte



Mobile  
Logistik



Windkraft-  
Anlagenbau



Temporäre  
Gehwege



Straßenbau  
und Zufahrtswege



Leitungsbau



Konzerte  
und Events



Mobile  
Parkplätze



## Abwassertank

Die ideale Lösung für Sanitäreinrichtungen in Gebieten ohne Kanalanschluss. Der Abwassertank wird unterhalb des Sanitärcontainers eingebaut und zu einer Einheit zusammengefügt. Wir bieten auch Extras wie eine passende Tanktreppe für einen bequemen Zugang zum darüber liegenden Container.



### Anwendungsbereiche:



Mobile  
Kranstellflächen



Schwerlast-  
transporte



Mobile  
Logistik



Windkraft-  
Anlagenbau



Temporäre  
Gehwege



Straßenbau  
und Zufahrtswege



Leitungsbau



Konzerte  
und Events



Mobile  
Parkplätze





## Messe- und Büromöbel

Wir bieten Ihnen alle Arten von Möbeln für Ihre individuell gestalteten Räume. Ob normale Büros oder mobile Raumsysteme, wir haben die ideale Lösung. Tische, Stühle, Tafeln und mehr...



### Anwendungsbereiche:



Mobile Kranstellflächen



Schwerlasttransporte



Mobile Logistik



Windkraft-Anlagenbau



Temporäre Gehwege



Straßenbau und Zufahrtswege



Leitungsbau



Konzerte und Events



Mobile Parkplätze



## Gabelstapler

In unserem Produktbestand haben wir viele verschiedene hochwertige Gabelstapler. Für all Ihre Anforderungen bieten wir Ihnen den idealen Stapler. Wir können Ihnen auch Transport und Dienstleistungen anbieten.



### Anwendungsbereiche:



Mobile Kranstellflächen



Schwerlasttransporte



Mobile Logistik



Windkraft-Anlagenbau



Temporäre Gehwege



Straßenbau und Zufahrtswege



Leitungsbau



Konzerte und Events



Mobile Parkplätze



## Klimaanlagen und Heizungen

Wo immer Sie Ihr Projekt haben, wir sorgen für die angenehmen klimatischen Bedingungen. Unsere Heizungen und Klimageräte können in Massivbauten und mobilen Raumsystemen eingesetzt werden. Für jede Raumgröße haben wir das ideale Produkt.



### Anwendungsbereiche:



Mobile Kranstellflächen



Schwerlasttransporte



Mobile Logistik



Windkraft-Anlagenbau



Temporäre Gehwege



Straßenbau und Zufahrtswege



Leitungsbau



Konzerte und Events



Mobile Parkplätze



## Stromaggregat

Wo immer Sie Strom brauchen, wir liefern ihn. Unsere Stromaggregate sind in verschiedenen Größen für individuelle Anforderungen erhältlich. Wir bieten auch Transporte für die Stromaggregate an.



### Anwendungsbereiche:



Mobile Kranstellflächen



Schwerlasttransporte



Mobile Logistik



Windkraft-Anlagenbau



Temporäre Gehwege



Straßenbau und Zufahrtswege



Leitungsbau



Konzerte und Events



Mobile Parkplätze



## Strom Zubehör

Zu allen unseren Generatoren bieten wir nützliches und sicheres Zubehör an. Teilen Sie uns bitte Ihr Anliegen mit und wir finden einen möglichen und sicheren Weg.



### Anwendungsbereiche:



Mobile  
Kranstellflächen



Schwerlast-  
transporte



Mobile  
Logistik



Windkraft-  
Anlagenbau



Temporäre  
Gehwege



Straßenbau  
und Zufahrtswege



Leitungsbau



Konzerte  
und Events



Mobile  
Parkplätze



# Kräne

Nichts ist zu hoch.  
Mit unseren mobilen  
Kränen erreichen Sie  
alles, was Sie brauchen.  
Wir bieten auch  
Transporte für unsere  
Kräne an.



### Anwendungsbereiche:



Mobile  
Kranstellflächen



Schwerlast-  
transporte



Mobile  
Logistik



Windkraft-  
Anlagenbau



Temporäre  
Gehwege



Straßenbau  
und Zufahrtswege



Leitungsbau



Konzerte  
und Events



Mobile  
Parkplätze



## Der Veranstaltungsanbieter

